

THE PROPERTY OF THE DRAWING IS ESTABLISHED BY LAW. IT IS FORBIDDEN TO PRODUCE OR SHOW IT TO THIRD PART. WITHOUT A WRITTEN AGREEMENT.

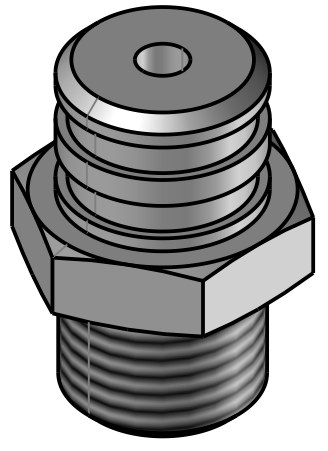

Format A4 UNI 936-76	GENERAL TOLERANCE UNI - ISO 2768 CLASSE f	DESCRIPTION CA.08.09.041	DESIGNED FROM FPS Automation	REVIEW A
			DATE 02/09/2022	WEIGHT 0,010kg
			CODE CA.08.09.041	

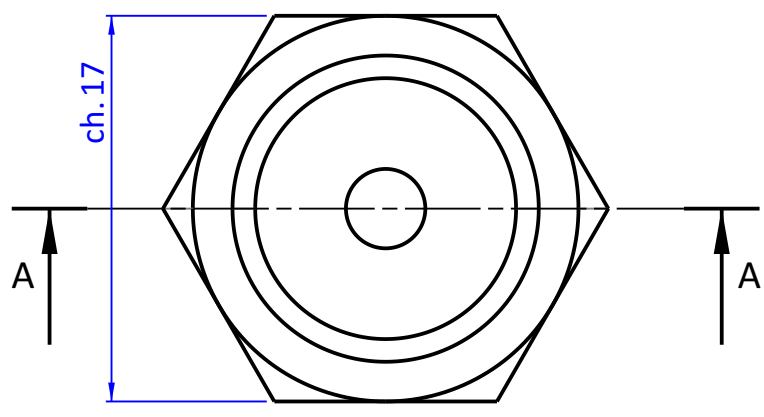
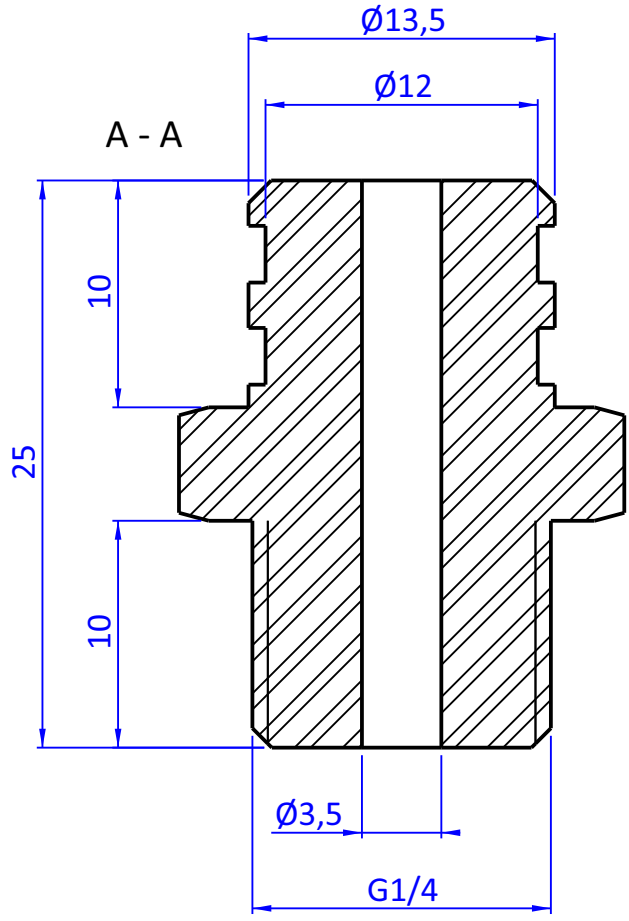